

Register your product and get support at
www.philips.com/welcome



VIDEO TRACER

VTR8100

VTR8100 使用手册 / User Manual

中文

03

English

35

PHILIPS



目录

1	欢迎	05	6	拍照	14
1.1	产品特点	05	7	录音	15
2	重要须知	06	8	一键回放模式	16
2.1	安全	06	9	视频模式	17
2.2	听力保护	06	9.1	视频播放	18
2.3	录音的法律限制	06	10	照片模式	19
3	您的数码音视频记录仪	08	11	语音模式	20
3.1	供货范围	08	11.1	语音播放	20
3.2	主机概览	08	12	遥控器	22
3.3	遥控器概览	09	12.1	遥控功能开关	22
4	开始使用	10	12.2	遥控器对码匹配	22
4.1	开 / 关机	10	13	连接 HDMI 高清输出	23
4.2	充电方法	10			
4.3	连接电脑	11			
5	录像	12			

14 设置模式	24
14.1 录音设置	24
14.2 录像设置	24
14.3 拍照设置	25
14.4 系统设置	27

15 电池的装取	31
15.1 装入电池	31
15.2 取出电池	31

16 背夹的装取	31
16.1 安装背夹	31
16.2 取下背夹	31

17 背夹佩戴方式	32
-----------	----

18 常见问题	33
---------	----

19 技术参数	34
---------	----

1 欢迎

欢迎来到飞利浦世界！您能选择和购买飞利浦的产品，我们非常高兴。您可在我们的官方网站上获得飞利浦公司的全方位技术支持，如：使用手册、软件下载、保修信息等。

www.philips.com

1.1 产品特点

- 一键录音：仅仅按下录音键即可实现录音，再按一下录音键保存录音。
- 一键录像：仅仅按下录像键即可实现录像，再按一下录像键保存录像。
- 一键回放功能：录音或者录像后，按停止键，直接进入文件播放。
- 真正采用立体声录音的音视频记录仪。
- 150° 超大广角镜头，录像无死角。
- 双滤光片切换器，白天不偏色，夜晚更清晰。
- 无线遥控功能，能远距离遥控开关机。
- 支持 HDMI 高清接口，方便显示器或电视机进行文件查看。
- 3.5mm 标准耳机，在嘈杂的环境下回放声音更清晰。
- 字符叠加功能，所有视频和照片都附加时间、产品编号、使

用者编号等信息，无法剪辑，更具法定证据效力。

- 超长文件名，所有录像文件的文件名都包含产品编号、时间、使用者编号等信息，方便数据存档、检索。
- 录像资料自动分割保存，防止误操作造成资料丢失。
- 外置存储卡，支持 256G。
- 高清扬声器：采用高品质振动喇叭，无论播放录音文件或录像文件，都给人身临其境的享受。
- 以常见的 WAV 格式录音。
- 使用高速 USB 2.0 快速存取录音文件和数据。
- 可作为大容量的 USB 存储设备，确保最大的兼容性。

2 重要须知

2.1 安全



注意

- 此符号标志指明处理或操作设备时必须遵守的各种注意事项。



小心

- 使用本产品前请仔细阅读本说明书，如因人为操作或不可抗力因素而导致数据丢失，本公司一概不予负责。特别提醒用户小心操作，注意将资料另外备份。

2.2 听力保护

使用耳机时请遵守下列原则：

- 调整至合适的音量，切勿长时间使用耳机。
- 特别需要注意，切勿将音量调至耳朵所能承受的范围之外。
- 切勿将音量调至盖过周边环境的声音。
- 在危险情况下请小心或暂停使用耳机。
- 在驾驶汽车、骑自行车、玩滑板时，切勿使用耳机。否则会导致交通意外，且违反相关法律法规。

2.3 录音的法律限制

- 本设备录音功能的使用可能受限于所在国家法律的限制。录制他人谈话或者课程时应尊重他人隐私及第三方人权。
- 请注意，在部分国家，当录制用户与他人通话时，用户应根据法律要求通知对方，否则该录音行为将被视为不合法。请在电话录音前确认使用人所在国家该录音数据使用的合法性。

所用符号标志



提示

- 此符号标志指明帮助您更加高效简便使用设备的信息。



注意

- 此符号标志指明处理或操作设备时必须遵守的各种注意事项。



小心

- 此符号标志警告可能发生的设备损坏和数据丢失。操作不当，可能导致损坏。



警告

- 此符号标志警告人身伤害危险。操作不当，可能导致人身伤害或设备损坏。
-

3 您的音视频记录仪

3.1 供货范围：

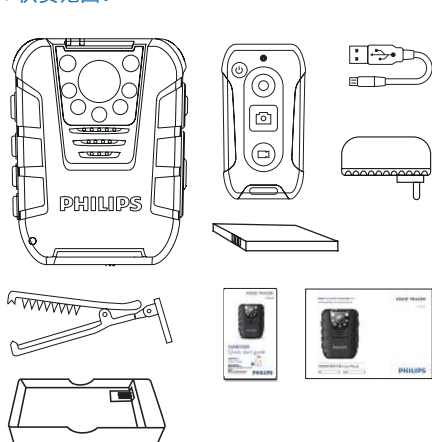

3.2 主机概览

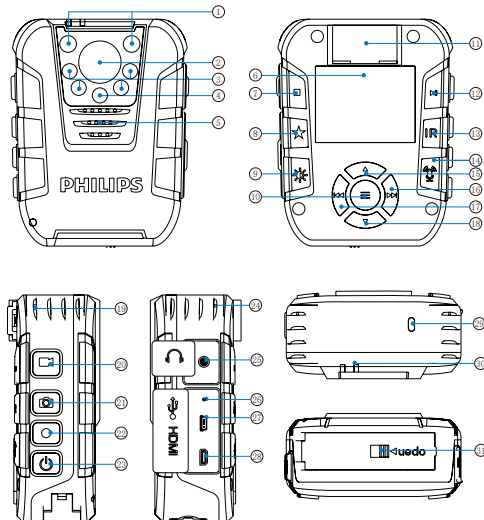

- ① 照明灯
- ② 镜头
- ③ 红外灯
- ④ 光敏电阻
- ⑤ 喇叭
- ⑥ 显示屏
- ⑦ 停止 / 返回键
- ⑧ 星标键
- ⑨ 照明键
- ⑩ 菜单键
- ⑪ 背夹固定槽
- ⑫ 播放 / 暂停键
- ⑬ 红外灯键
- ⑭ 灵敏度键
- ⑮ 音量加 / 菜单选项选择 / 文件选择键
- ⑯ 下一曲 / 快进 / 菜单选择键
- ⑰ 上一曲 / 快退 / 菜单选择键
- ⑱ 音量减 / 菜单选项 / 文件选择键
- ⑲ 麦克风
- ⑳ 录像键
- ㉑ 拍照键
- ㉒ 录音键
- ㉓ 电源 / 关屏键

- ㉔ 麦克风
- ㉕ 耳机接口
- ㉖ 复位键
- ㉗ HDMI 接口
- ㉘ USB 接口
- ㉙ 遥控指示灯
- ㉚ 状态指示灯
- ㉛ 电池门

3.3 遥控器概览:

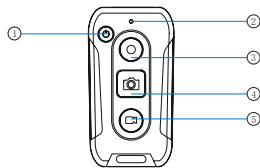

- ① 开 / 关机键
- ② 遥控器指示灯
- ③ 录音键
- ④ 拍照键
- ⑤ 录像键

4 开始使用

4.1 开 / 关机

注意

- 第一次使用机器时，请对该机器在关机状态下充电 3 小时以确保机器有电工作！

关机状态下，长按开机键 3s，本机立即自动开机，然后显示飞利浦图标，如下图所示：



然后机器进入预览界面，如下图所示，预览状态下，工作状态指示灯亮绿灯，在此界面短按 MENU 键，机器回到设置界面。长按“▲”或“▼”放大与缩小预览界面，实现数码变焦功能。按“灵敏度”按键将会弹出快捷麦克风灵敏度菜单，设置所需要的录音增益。

10 ZH



提示

- 本机使用可拆卸锂电池供电，如果长时间不使用音视频记录仪，请长按开关机键 3s 关掉机器。
- 如果音视频记录仪无法正常工作，请确认机器是否已没电。
- 机器工作过程中，请勿直接把外置卡拔出，否则会损坏文件或导致机器异常。
- 当电量指示标志为“”时，请及时充电。或者更换电池，如果更换电池，请于 3 分钟内更换完成。

4.2 充电方法

- 本产品配有可置换电池，可将电池取出用出厂配的座充和充电盒进行充电。
- 使用 USB 数据线将本机与 PC 相连接，充电过程中充电指示灯常亮绿色，充满后熄灭。
- 使用 USB 数据线将本机和出厂配备的充电器进行充电，充电

过程中充电指示灯常亮绿色，充满后熄灭。

(4) 本机配备的遥控器使用锂电池供电，使用 USB 数据线将本机和出厂配备的充电器或者连接电脑进行充电，充电过程中充电指示灯常亮绿色，充满后熄灭。

提示

- 本机充电可以使用关机充电和开机充电的方式，一般情况下，关机充满电需要 2.5 小时左右，开机充满电需要 5 小时左右（建议关机充电）。

提示

- 在文件移入或移出录音笔时，请不要断开音视频与电脑的连接。
- 请将机器开机后再使用 USB 数据线将音视频记录仪与电脑相连或者使用 USB 数据线将音视频记录仪与电脑相连后长按电源键 3s。

4.3 连接电脑

音视频记录仪可作为大容量的 USB 存储设备，并可方便地记录仪与电脑相连，且无须安装软件，音视频会自动显示为可移动设备，连接电脑图标如下图所示。



5 录像

当您初次使用音视频记录仪录像时，请注意本节中的内容说明！

- (1) 在摄像预览状态按下“录像”键开始录像，机器短振两下，状态指示灯将红灯闪烁。
- (2) 长按“▲”或“▼”放大与缩小预览界面，实现数码变焦功能。
- (3) 在黑夜或者光线暗的环境下录像时，如果红外切换为手动切换，可以按下“IR”键，此时红外灯开启进入到夜视拍摄模式，画面颜色为黑白模式。
- (4) 在黑夜或者光线暗的环境下录像时，按下“☀️”键，照明灯将打开，补充光源。
- (5) 按“拍照”键可以抓拍当前拍摄画面。
- (6) 按下“★”键，文件将会标记为重要文件，循环录像打开时，此文件不会被删除。
- (7) 长按“录音”键，音视频记录仪将转到录音模式进行录音。
- (8) 再次短按“录像”键结束录像，机器短振两下，红色指示灯灭，并回到摄像预览状态界面，状态指示灯亮绿色。

录像参考界面如下如所示：



录像界面说明：



- ① 录像分辨率
- ② 系统当前日期
- ③ 时间水印
- ④ ID 号水印
- ⑤ ID 号
- ⑥ 录像状态
- ⑦ 当前录像时间
- ⑧ 电量指示
- ⑨ 系统当前时间
- ⑩ 卡剩余容量
- ⑪ 卡标志



注意

- 电池标记符显示空格时,表明低电。低电时系统会自动关机。如果正在录像或者录音,系统自动保存录音文件后再关机。电量不足时,请及时充电。低电关机时机器会有震动提示,显示屏也会有相应的提示,显示屏的提示图标如下所示:



提示

- 录像前,请先设置所需的录像参数。
- 请先删除一些不必要的文件再录。
- 本机有感光元件,如果红外切换设置为自动切换,当环境光线暗到一定值时,红外灯自动打开。

6 拍照

当您初次使用音视频记录仪拍照时，请注意本节中的内容说明！在摄像预览状态下，直接按拍照按键进行拍照，拍照时红色指示灯亮，并发出“咔嚓”一声，在黑夜或者光线暗的环境下拍摄需要开启机器红外灯或补光灯进行拍摄。在录像状态下，按下拍照按键可以抓拍当时摄录照片。

7 录音

当您初次使用音视频记录仪录音时，请注意本节中的内容说明！

- 1 在摄像预览状态按下“录音键”开始录音；工作状态指示灯将亮黄灯； 请将内置麦克风对准音源。
- 2 按下“★”键，文件将会标记为重要文件，循环录像打开时，此文件不会被删除。
- 3 长按“录像”键，音视频记录仪将转到录像模式进行录像。
- 3 按下“录音”键结束录音，并回到预览界面。

录音参考界面如下如所示：



录音界面说明



- ① 录音状态
- ② 系统当前时间
- ③ 当前录音时间
- ④ 电量指示

提示

- 录音前，请先设置所需的录音类型。
- 请先删除一些不必要的文件再录。
- 请先测试录音，以确保音视频记录仪设置是否正确。
- 在录音或者录像过程中禁止直接将卡拔出，否则可能导致文件损坏。
- 录音或者录像时请勿断电，否则这会导致音视频记录仪故障，文件丢失或文件损坏等问题。
- 如果需要长时间使用，请在录音前充电。

8 一键回放模式

当您初次使用音视频记录仪拍照时，请注意本节中的内容说明！在摄像预览状态下，录像保存后，短按停止键，音视频记录仪将直接播放你刚刚摄录的录像文件。录音保存后短按停止键，音视频记录仪将直接播放你刚刚录的录音文件。机器刚刚开机启动，一键回放功能默认为播放最近摄录的录像文件。

9 视频模式

在摄像预览状态界面中，我们可以使用播放键进入查阅回放界面，按“◀◀”或“▶▶”键，选择视频回放选项，然后短按播放键确认进入视频文件列表界面，视频文件列表参考界面如下图所示：



此界面下，按“★”键即可将当前选中文件标记为重要文件，循环录像打开时，此文件不会被覆盖。只有通过连接电脑才可以删除该文件。

在按“◀◀”或“▶▶”键选择需要播放的视频文件，短按播放键进入视频播放停止界面，视频播放停止参考界面如下图所示：



录像文件播放界面说明：



- ① 播放状态
- ② 当前时间
- ③ 播放进度条
- ④ 总时间
- ⑤ 时间文件名

9.1 视频播放

- (1) 按“⏮”或“⏭”键，选择要播放的文件。
- (2) 按“播放”键开始播放，工作状态指示灯将亮绿灯。
- (3) 使用“▲”或“▼”键调节音量。
- (4) 按“停止”键结束播放，并返回视频文件列表界面。
- (5) 播放过程中，按播放键暂停播放，再次按下播放键，将继续先前位置的播放。
- (6) 播放时短按“⏮”或“⏭”键，可选择2倍，4倍，8倍，16倍，32倍，64倍，128倍快退或快进当前正在播放的文件。



提示

- 当耳机插入插孔内，录音笔扬声器被关闭。

10 照片模式

在摄像预览状态界面中，我们可以使用播放键进入查阅回放界面，按“◀◀”或“▶▶”键，选择拍照回放选项，然后短按播放键确认进入。然后，短按播放键进入拍照文件列表界面，拍照文件列表参考界面如下图所示：

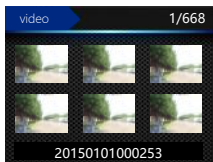

此界面下，按“★”键即可将当前选中文件标记为重要文件，循环录像打开时，此文件不会被覆盖。只有通过连接电脑才可以删除该文件。

按“◀◀”或“▶▶”键选择需要播放的照片文件，短按播放键进入照片浏览状态，按“◀◀”或“▶▶”键选择要查看的照片。

11 语音模式

在摄像预览状态下，你可以使用播放键进入查阅回放界面，按“◀◀”或“▶▶”键，选择录音回放选项，然后短按播放键确认进入语音文件列表界面，语音文件列表参考界面如下图所示：



此界面下，按“★”键即可将当前选中文件标记为重要文件，循环录像打开时，此文件不会被覆盖。只有通过连接电脑才可以删除该文件。

按“◀◀”或“▶▶”键选择需要播放的音频文件，短按播放键进入语音播放停止界面，语音播放停止参考界面如下图所示：

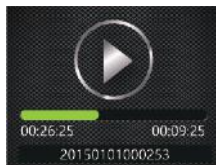

语音文件播放界面说明：



- ① 播放状态
- ② 当前时间
- ③ 时间文件名
- ④ 播放进度条
- ⑤ 总时间

11.1 语音播放

- (1) 按“◀◀”或“▶▶”键，选择要播放的文件。
- (2) 按“播放”键开始播放，工作状态指示灯将亮绿灯
- (3) 使用“▲”或“▼”键调节音量。
- (4) 按“停止”键结束播放。并返回语音文件列表界面。
- (5) 播放过程中，按播放键暂停播放，再次按下播放键，将继续先前位置的播放。



提示

- 当耳机插入插孔内，录音笔扬声器被关闭。

12 遥控器

遥控器可以方便远距离操控机器，本机配备的遥控器有遥控开关机，录音，录像，拍照等功能。

12.1 遥控功能开关

(1) 机器关机状态下，如果白色遥控指示灯熄灭，此时机器不能使用遥控功能，此状态下按菜单键3秒，白色遥控器指示灯亮起，随后进入慢闪状态，便打开遥控功能。

(2) 机器关机状态下，如果白色遥控指示灯常亮慢闪，此时遥控功能为开启状态，可以按遥控器上的开机键实现远程遥控开机。此状态下按菜单键3秒，白色遥控指示灯熄灭，关闭遥控功能。



提示

- 使用遥控器操作机器前，需将机器的遥控功能开启。
- 第一次使用遥控器时，请对遥控器充电2小时以确保遥控器有电工作！
- 如果对码成功后在使用遥控器的过程中，发现遥控器上的红色指示灯一直在闪烁（或者指示灯不能亮起来）。说明遥控器已低电，请及时对遥控器进行充电。
- 遥控功能的开启和关闭只能在音视频记录仪关机状态下进行。

行，只有机器上的白色遥控指示灯慢闪时，遥控功能才处于开启状态。

- 对码成功且遥控功能打开下，按下遥控器上的按键后，如果遥控器上的红色指示灯亮起，说明遥控操作起作用。拍照时遥控器上的红色指示灯闪烁一次；录音和录像启动时，遥控器上的红色指示灯闪烁两次；录音和录像保存时，遥控器上的红色指示灯闪烁三次。
- 遥控距离要求：在2米内无阻碍水平任意角度均能遥控。

12.2 遥控器对码匹配

在机器关机并且遥控功能关闭状态下，长按菜单键8秒使机白色遥控指示灯进入快闪状态，在10秒内须按下遥控器上的任意按键，如果白色遥控指示灯先长亮10秒，之后进入5秒闪亮一次，则对码成功。为验证对码成功，可以按下遥控器上的开机键，机器将会自动开机，否则对码失败。

13 连接 HDMI 高清输出

在预览状态下，使用 Micro HDMI 转 HDMI 线，将本机连接到高清显示设备上，在连接显示设备后，本机的所有操作功能仍然可以操作。



提示

- 在连接 HDMI 时，显示设备的画面会与显示屏的画面有一些不一致的现象。

14 设置模式

在摄像预览状态界面按下菜单键，系统将会进入设置界面。系统设置界面相关参考图片如下图所示，包括：录音设置，录像设置，拍照设置和系统设置。

14.1 录音设置

录音设置菜单栏包括：录音类型和麦克灵敏度。按“◀◀”或“▶▶”键选择选择录音设置菜单图标，按“▲”或“▼”键选择所需设置的选项，然后按菜单键进入。

14.1.1 录音类型

在录音类型菜单中有两种录音类型可供选择：“立体声、长时间”。如果选择的是立体声音音类型，则在录音达到一个小时后，机器自动保存录音文件，然后进行下一个录音。参考界面如下图所示：



立体声：WAV 格式，高音质，比特率为 1536kbps。
长时间：WAV 格式，一般音质，比特率为 385kbps。

14.1.2 麦克灵敏度

在麦克灵敏度菜单中有三种增益可供选择：“高，中，低”。选择不同的麦克灵敏度可以达到不同的录音效果。

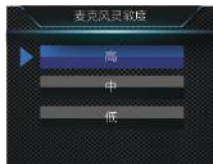

14.2 录像设置

录像设置菜单栏包括：分辨率，视频质量，视频预录，视频延录。按“◀◀”或“▶▶”键选择选择录像设置菜单图标，按“▲”或“▼”键选择所需设置的选项，然后按菜单键进入。

14.2.1 分辨率

录像分辨率有 1920×1080 30P、1280×720 60P、1280×720 30P、848×480 60P、848×480 30P 五个级别，多种录像分辨率选择，可满足大部分应用场合，按“▲”或“▼”选择按键选择合适的分辨率，选择完成后按菜单键确定，按返回键可返回上一级菜单。

参考界面如下图所示：

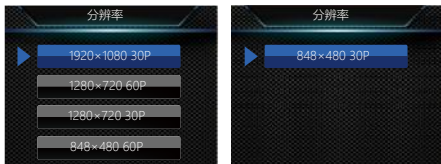

14.2.2 视频质量

在视频质量菜单中有三种画质可供选择：“超精细”，良好，正常”。根据不同的需求选择不同的画质效果，画质越好，相同录像时间所占的内存越大。

14.2.3 视频预览

使用视频预览功能，你可以提前录制事件触发前十几秒到几十秒的画面，视频预览有关闭和打开两种选择，按“▲”或“▼”键进行选择，选择完成后按菜单键确定，按返回键可返回上一

级菜单。

14.2.4 视频延录

使用视频延录功能，你可以在按下按键保存录像后继续摄录设定的时间，视频延录设置关闭、5秒、10秒、15秒、30秒、60秒六个选择，按“▲”或“▼”键进行选择，选择完成后按菜单键确定，按返回键可返回上一级菜单。

14.3 拍照设置

拍照设置菜单栏包括：照片大小，照片质量，连拍，自动拍照。按“◀◀”或“▶▶”键选择选择拍照设置菜单图标，按“▼”或“▲”键选择所需设置的选项，然后按菜单键进入。

14.3.1 照片大小

拍照照片的大小为 20M、16M、14M、12M、8M、5M、3M、2M、1.2M、VGA 这个 10 个级别，按“▲”或“▼”选择按键选择合适的分辨率，选择完成后按菜单键确定，按返回键可返回上一级菜单。参考界面如下图所示：



14.3.2 照片质量

在拍照设置菜单中，选择“照片质量”菜单，再按菜单键进入照片质量菜单。在视频质量菜单中有三种画质可供选择：“超精细”，良好，正常”。根据不同的需求选择不同的画质效果，画质越好，相同录像时间所占的内存越大。

14.3.3 连拍

连拍是指在取景预览模式下或在录像过程中，按一次拍照键相机能够连续拍摄照片。

在拍照设置菜单中，选择“连拍”菜单，再按菜单键进入连拍菜单。连拍设置可以设置关闭、3张、5张、10张、20张五个选择，按“▲”或“▼”键选择合适的连拍张数，选择完成后按确认键确定，按返回键可返回上一级菜单。

14.3.4 自拍

自动拍照是指在取景预览模式下或在录像过程中，按一次拍照键相机每隔一定的时间拍摄一张照片，直到按下拍照键取消或者卡满和没电为止。

自动拍照可以设置关闭、3秒、5秒、10秒、30秒、60秒六个选择，按“▲”或“▼”键选择合适的秒数，选择完成后按确认键确定，按返回键可返回上一级菜单。

14.4 系统设置

系统设置菜单栏包括：语言，系统制式，默认设置，屏亮度，系统时间，自动关机，自动关屏，音量，车载模式，循环录像，车载录音，分段录像，按键音，指示灯，红外切换，移动侦测，曝光补偿 和系统信息。按“◀◀”或“▶▶”键选择选择系统设置菜单图标，按“▲”或“▼”键选择所需设置的选项，然后按菜单键进入。

14.4.1 语言

在语言选择菜单中，你可以选择一种语言作为系统语言。语言选择参考界面如下：



14.4.2 系统制式

系统制式也称电视广播制式，有 NTSC 和 PAL 两大制式，机器做为电视输出时要根据电视机的制式选择正确的选项。

14.4.3 默认设置

使用此功能，你可以重置机器的设置选项。

14.4.4 屏亮度

使用此功能，可以根据需要调节显示屏的亮度。屏亮度设置可以设置高、中、低三个级别，按“▲”或“▼”键选择合适的选项，选择完成后按确认键确定，按返回键可返回上一级菜单。

14.4.5 系统时间

系统时间设置界面，参考图片如下：



在此界面下，按“▲”或“▼”与“◀◀”和“▶▶”可以设置实时时间。按“◀◀”和“▶▶”选择年、月、日；按“▲”或“▼”改变相应位置数值。

14.4.6 自动关机

如果在设定的时间内没对机器做任何操作，系统将会自动关机。自动关机设置参考界面如下：

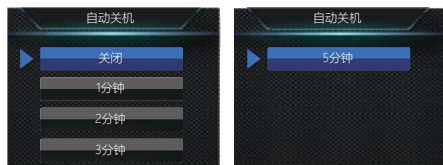

14.4.7 自动关屏

自动关屏时间有五种时长可供选择：关闭、1分钟、2分钟、3分钟和5分钟。如果在设定的时间内没对机器做任何操作，显示屏将会自动灭。如果选择“关闭”，显示屏将会常亮。

14.4.8 音量

使用此功能，你可以设置机器的输出音量。

音量设置可以从0~16之间17个数值选择，按“▲”或“▼”键选择合适的音量值，选择完成后按菜单键确定。

14.4.9 车载模式

本机可以当行车记录仪使用，车载模式默认为“关闭”，“循环录像”和“车载录音”这两个选项为灰色，不能选择。▼车载模式选择“打开”后，“循环录像”和“车载录音”这两个菜单选项变成可选，并且“自动关屏”默认为关。

14.4.10 循环录像

在录像设置菜单中，选择“循环录像”菜单，再按菜单键进入循环录像菜单。有关闭和打开两种选择，按“▲”或“▼”键进行选择，选择完成后按菜单键确定，按返回键返回上一级菜单。在录像设置菜单中，选择“循环录像”菜单，再按菜单键进入循环录像菜单。有关闭和打开两种选择，按“▲”或“▼”键进行选择，选择完成后按菜单键确定，按返回键返回上一级菜单。



14.4.11 车载录音

使用此功能，你可以选择是否需要录下车内的声音。

14.4.12 分段录像

视频分段有5分钟、10分钟、15分钟、20分钟、30分钟五个级别，在录像过程中，视频分段在每所设定的时间自动将视频文件分段保存并自动进入下一个文件录像，并且是无缝切换。视频分段功能参考界面如下图所示：

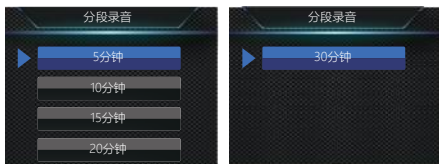

14.4.13 按键音

使用此功能，你可以根据需要打开或者关闭按键操作提示音。

14.4.14 指示灯

使用此功能，你可以根据需要打开或者关闭状态指示灯。

14.4.15 红外切换

在系统设置菜单中，按 ▲ 或 ▼ 键选择“红外”菜单，再按菜单键进入红外切换菜单。红外切换可以设置手动、自动两种选择，选择完成后按确认键确定，按返回键可返回上一级菜单。

14.4.16 移动侦测

音视频记录仪在侦测状态下，有物体进入音视频记录仪拍摄范围内后自动开启录像功能，物体离开音视频记录仪拍摄范围内后结束录像功能并保存录像文件。自移动侦测功能有四种设置可供选择：关闭、低、中和高。你可以根据需要将移动侦测功能关闭或者选择一个合适的灵敏度。

14.4.17 曝光补偿

曝光补偿是一种曝光控制方式，曝光补偿可以让照片更明亮或者更昏暗的拍摄手法。可以根据自己的想法调节照片的明暗程度，创造出独特的视觉效果等。

曝光补偿设置可以从 -2.0~+2.0 之间 13 个数值选择，按 “ ” 或 “ ▼ ” 键选择合适的曝光值，选择完成后按菜单键确定。

14.4.19 ID号

ID号设置界面，参考图片如下：



在此界面下，按 “▲” 或 “▼” 与 “◀◀” 和 “▶▶” 可以设置机器的设备编号和用户编号。按 “▲” 和 “▼” 选择相应的数字位置；按 “◀◀” 或 “▶▶” 改变相应位置数值。

14.4.20 系统信息

系统信息菜单中包括：总存储容量，可用空间，可用录像时间，可用录音时间，电池电量和版本号。

总存储容量：使用此功能，你可以查看本机内存大小信息。

可用空间：使用此功能，你可以查看剩余空间信息。

可用录像时间：使用此功能，你可以查看当前录像分辨率可以录像多久。

可用录音时间：使用此功能，你可以查看当前录音类型可以录音多久。

电池电量：使用此功能，你可以查看当前电池电量信息。

版本号：使用此功能，你可以查看固件版本信息。

15 电池的装取

15.1 装入电池

- (1) 将电池门往“OPEN”的方向拨动，然后打开电池盖。
- (2) 将电池按照正确的方向推进电池盒。如下图所示：

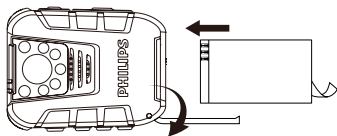

- (3) 关上电池门，将电池门往“OPEN”的反方向拨动。

15.2 取出电池

- (1) 将电池门往“OPEN”的方向拨动，然后打开电池盖。
- (2) 翻出电池尾部的拉带，然后夹紧拉带往外拉。
- (3) 关上电池门，将电池门往“OPEN”的反方向拨动。

16 背夹的装取

16.1 安装背夹

背夹与机器的滑槽①对应好，按②的方向装入背夹。如下图所示：

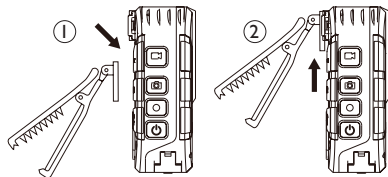

16.2 取下背夹

取出背夹时按相反的方向并加向上的力拉出。

17 背夹的佩戴方式

(1) 压住手夹位使夹子口张开，然后朝着肩章夹入，使夹钩钩住肩章的纽扣根部。

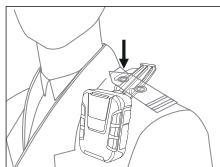

(2) 松开手夹位，使夹子夹住肩章，并将机器调整至合适位置。

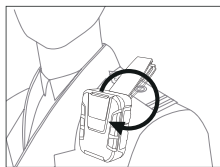

18 常见问题

此处列举了常见问题的解答，可帮助解决音视频记录仪出现的简单问题。如果故障仍无法排除，请咨询经销商或访问我们的官方网站：

www.philips.com/support

无法启动音视频记录仪：

电池电量已耗尽请及时充电。

显示时间 / 日期不正确：

音视频记录仪时间不准确，请在菜单上重新设置时间。

拍照 / 录像图像模糊，不清楚：

镜头不干净。请用干净的绒布清洁镜头。

音视频记录仪无法录音或者录像：

音视频记录仪存储空间已满并且未开启循环录像。请删除部分文件或将其移至外部存储设备。

音视频记录仪无法播放录音或者录像：

电池电量已耗尽，请充电。

音视频记录仪死机后如何处理：

你有时在操作中会遇到开不了机，黑屏，操作不了等死机现象，通常处理方法是，复位一下，复位键位置：掀开 USB & HDMI 的塞子，在 HDMI 接口的上端有一个小孔，用镊子或尖的东西点按一下小孔即可。

注：本操作不会造成文件数据丢失或者损坏。

19 技术参数

存储器

外置存储空间

参考录音时间（16GB）：立体声录音模式约 22 小时，长时间录音模式约 90 小时。

内置存储器类型：C10 TF 卡

移动存储器（PC）：是

尺寸和重量

宽 × 高 × 深：72×54×27（mm）

重量（含电池）：106g

系统要求

操作系统：Windows 10/8/7/Vista/XP/2000, Mac OS X, Linux

接口：USB 接口

录音

立体声：比特率为 1536kbps，格式为 WAV

长时间：比特率为 385kbps，格式为 WAV

运行条件

温度：-30° — 55°

空气湿度：10% — 90%，不凝结

Table of Contents

1 Welcome	37	8 One-touch Playback Mode	47
1.1 Product highlights	37	9 Video Mode	48
		9.1 Video Playback	48
2 Important	38	10 Camera Mode	50
2.1 Safety	38	11 Voice Mode	51
2.2 Hearing safety	38	11.1 Voice Playback	52
2.3 Legal restrictions on recording	38	12 Remote Control	53
3 Your Video & Audio Recorder	39	12.1 Remote Control Enable/Disable	53
3.1 What's in the box?	39	12.2 Matching the Remote Control	53
3.2 Overview	39	13 HDMI	54
3.3 Remote control overview	40	14 Settings Mode	55
4 Get Started	41	14.1 Voice Settings	55
4.1 Power On/Off	41	14.2 Video Settings	56
4.2 Recharge	42	14.3 Camera Settings	57
4.3 PC Connection	42	14.4 System Settings	58
5 Recording	43	15 Changing the battery	63
6 Camera	45	15.1 Battery loading	63
		15.2 Battery unloading	63
7 Voice Recording	46	16 How to use the back clip of the device	64

16.1 Back clip installment	64
16.2 Back clip uninstallment	64
17 How to wear the back clip	64
18 FAQs	65
19 Technical Parameters	66

I Welcome

Congratulations on your purchase and welcome to Philips! To fully benefit from the support that Philips offers, visit our website for support information such as user manuals, software downloads, warranty information and more: www.philips.com

1.1 Product Highlights

- One-touch voice recording: Just press the voice record button to start recording, and then press again to save the file.
- One-touch video recording: Just press the video record button to start recording, and then press again to save the file.
- One-touch playback: After voice or video recording, press the stop button to play the file.
- Real HQ voice and video recorder.
- 150° ultra-wide angle lens free from dead zones for video recording.
- Double-filter switcher for images without color deviation during the day and clearer images at night.
- Wireless control for remote power on/off.
- HDMI for convenient file check on monitor or TV settings.
- 3.5mm standard earphone connector enabling use of earphones in noisy environments.
- Character superimposing for improved legal evidence by adding time, product number and user code to all videos and images, which cannot be edited.
- Super-long file name containing product number, time, and user ID, etc for data archiving and searching
- Automatic partitioning and saving of video files against loss by erroneous operation.
- Support external storage capacity: 256G.
- HQ vibrating speaker giving you a live effect while playing voice and video files.
- Recording in the common WAV format.
- USB2.0 for rapid access to recorded files and data.
- Use as a USB mass storage to ensure the best compatibility.

2 Important

2.1 Safety

- Protect the cables from being pinched, particularly at plugs.



Note

- Please read this User Manual carefully before using the device. The company shall not be liable for any data loss caused by force majeure. Special attention should be given to correct operations and file backup.

2.2 Hearing safety

Observe the following guidelines when using your headphones:

- Adjust to a desired volume; do not use headphones for a long period of time.
- Please remember not to turn the volume up beyond your tolerance.
- Do not turn up the volume so high that you can't hear what's being said around you.
- Use caution or temporarily discontinue use in potentially

- Adjust to a desired volume; do not use headphones for a long period of time.
- Please remember not to turn the volume up beyond your tolerance.
- Do not turn up the volume so high that you can't hear what's being said around you.
Use caution or temporarily discontinue use in potentially hazardous situations.
Do not use headphones when driving, cycling, and skateboarding to avoid traffic accidents and violating laws and regulations.

2.3 Legal restrictions on recording

- The use of the device's recording function is subject to the legal restrictions that may apply in your country. You should also respect the privacy and personal rights of the third parties if you record talks or lectures.
- Please note that, in certain countries, you may be legally required to inform the person you are conversing with on the telephone that you are recording the conversation, or that the recording of telephone conversations is illegal. Please check if the use of such data is legal in your country prior to recording telephone calls.

3 Your digital recorder

3.1 What's in the box?

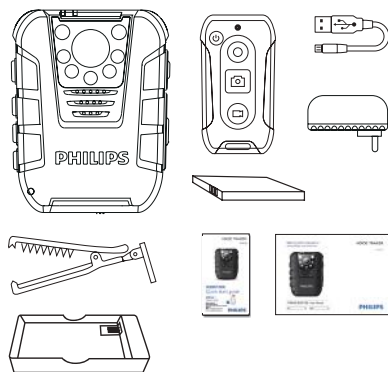

3.2 Overview:

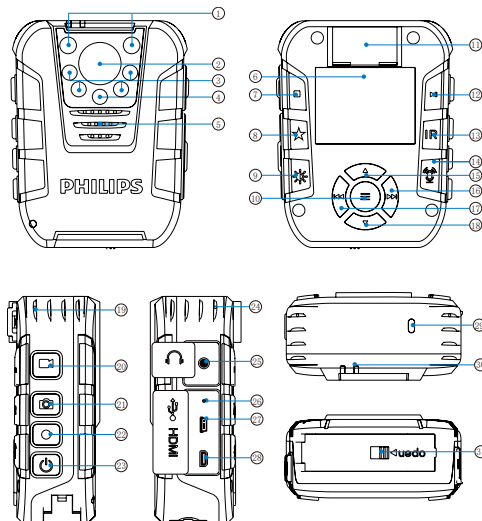

- ① Lamp
- ② Camera
- ③ Infrared lamp
- ④ Light sensor
- ⑤ Speaker
- ⑥ Display
- ⑦ Stop/Return button
- ⑧ File marking
- ⑨ Lighting
- ⑩ Menu
- ⑪ Back clip groove
- ⑫ Play/Pause
- ⑬ Infrared button
- ⑭ Microphone sensitivity
- ⑮ Increasing volume/Menu option/ file choosing
- ⑯ Next track/Fast forward/Menu option choosing
- ⑰ Last track/Fast forward/Menu option choosing
- ⑱ Decreasing volume/Menu option/ file choosing
- ⑲ Microphone
- ⑳ Video recording
- ㉑ Photo taking
- ㉒ Voice recording
- ㉓ Power/LCD off
- ㉔ Microphone
- ㉕ Headphone jack
- ㉖ Reset
- ㉗ HDMI interface

- ㉘ USB interface
- ㉙ Remote control indicator
- ㉚ Working status indicator
- ㉛ Battery cover latch

3.3 Remote control overview:

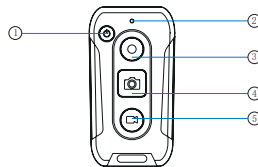

- ① Power on/off
- ② Remote indicator
- ③ Voice recording
- ④ Photo taking
- ⑤ Video recording

4 Get Started

4.1 Power On/Off



Note

- Please charge the device for 3 hours in the status of power off before using it for the first time!

When the device is off, it can be started by pressing the Power On/Off button for 3s; the screen then displays the "PHILIPS" logo. See the picture below:



Then the device displays the preview interface as seen in the following figure. On this interface, the status indicator becomes green; press Menu button quickly to return to the Settings interface. Long press "▲" or "▼" to zoom in or out the preview interface. Press "sensitivity" button and the menu will pop-up, then the record gains setting will be available.



Note

- The device has a built-in lithium battery. If the device is idle for a long time, please turn off the device by pressing the Power On/Off button for 3 Sec.
- If the device doesn't work normally, please make sure the device is not out of power.
- When the device is working, do not unplug the external card directly, or it may damage files or cause a malfunction.
- When the battery indicator symbol "  " is displayed, please charge the device promptly or replace the battery, less than 3 minutes recording time are left.

4.2 Recharge

- 1 The device has a replaceable battery, which can be taken out and recharged with the supplied desktop recharger or case recharger.
- 2 The device can be connected to a PC using the USB cable. When recharging, the indicator remains green. When the indicator goes out, the device is fully recharged.
- 3 The device can be connected to the recharger using the USB cable. When recharging, the indicator remains green. When the indicator goes out, the device is fully recharged.
- 4 Lithium battery is used for the remote control. Charging the device with the equipped charger or connecting the device to PC with a USB cable. During the charging, the charging indicator is green, and it will go off if the device is fully charged.



Note

- Recharging may be conducted when the device is either off or on. Under normal circumstances, the device will be fully recharged within 2.5 hours when it is off, or about 5 hours when it is turned on.

4.3 PC Connection

The Voice Tracer can be used as a USB mass storage to conveniently store, back up and move files. The Voice Tracer can be linked to a computer with a USB cable. The Voice Tracer can automatically be recognized as a mass storage device without the need to install any software, as shown in the following picture.



Note

- When moving files to or from the recorder, please do not disconnect the device from the computer.
- Please connect the device with PC with the USB cable when the device is power on or long press the power button for 3 seconds after connecting the device to PC.

5 Video Recording

Please note the instructions in this section when you make the first video recording with your Voice Tracer!

- (1) On the Preview interface, press the "Video Record" button to start recording. The device will vibrate twice briefly, and the state indicator flickers red.
- (2) Long press "▲" or "▼" to zoom in and out the preview interface.
- (3) When recording at night, in a low light environment or of the infrared is in manual mode, please press the "IR" button to change to night recording mode. The screen will become black/white.
- (4) When recording at night or in a low light environment, press the "☀️" button to gain more light.
- (5) Press the "Capture" button to capture the current video recording picture.
- (6) Press the "★" button to mark the file as an important document, so the file will not be covered when loop recording or be deleted on the device. It can only be deleted by formatting the device or through computer.
- (7) Long press voice recording button to transfer from video recorder to voice recorder.
- (8) Press the "Video Record" button again to end the recording. The device will vibrate twice briefly, the red light

goes out, and the device returns to the preview interface. The state indicator turns green.

Recording Interface Reference:



Illustration of Video Recording Interface:



- ① Resolution
- ② Current system date
- ③ Time watermark
- ④ ID Number watermark
- ⑤ ID Number
- ⑥ Video record state
- ⑦ Current recording time
- ⑧ Battery
- ⑨ Current system time
- ⑩ Remain video
- ⑪ TF card

 Note

- When the low battery icon appears, it means the battery is nearly empty and the system will automatically shut down. If the device is recording, the system will automatically save the recorded file, then shut down. If the device has a low battery, please recharge the device promptly. When the device shuts down on a low battery, it will vibrate and the following icon will be displayed.



 Note

- Prior to video recording please set the desired recording parameters.
- Please delete any unnecessary files before recording.
- For video recording in the dark, press the infrared button to enter the night mode. The recorded video will be black and white.

6 Camera

Please note the instructions in this section when you take the first photo with your Voice Tracer!

On the preview interface, press the Camera button to take a photo. While taking a photo, a red light appears with a “click” sound. If taking a photo in a dark environment, the device needs its infrared lamp or additional lamp to secure good quality videos. During the video recording the user can press the camera button to make a photo.

7 Voice Recording

Please note the instructions in this section when you make the first voice recording with your Voice Tracer!

- 1 On the preview interface, press the "Voice Record" button to start recording. The status indicator turns yellow.
Please rotate the built-in microphone toward the source of sound.
- 2 Press the "★" button to mark the file as an important document, so the file will not be deleted by loop recording.
- 3 Long press voice recording button to transfer from video recorder to voice recorder.
- 4 Press the "Record" button to end recording. The device returns to the Preview interface.

Illustration of Recording Interface:



- ① Record state ③ Status of the battery
② Current recording time

Note

- Prior to recording, please preset the type of recording you need.
- Please delete any unnecessary files before recording.
- Make a test recording to make sure that the Voice Tracer settings are correct.
- When recording, please do not remove the card or the recorded file may be damaged.
- When recording, please do not cut off the power supply or the Voice Tracer will fail; loss or damage to recorded files may occur.
- If the recorder needs to be used for a long time, please charge the device before recording.

8 One-touch Playback Mode

Please note the instructions in this section when you take the first photo with your Voice Tracer!

On the Preview interface, press the Stop button quickly after the video recording file is saved, the Voice Tracer will directly play the file. Press the Stop button quickly after the voice recording file is saved, the Voice Tracer will directly play the file. By default, the one-touch playback will play the last video recording file as soon as the device is powered on.

9 Video Mode

On the preview interface, you can enter the playback review interface through the Play button; press the “◀◀” or “▶▶” button to select Video Playback, and then press the Play button quickly to enter the video file list interface. The video file list interface is shown in the following figure:

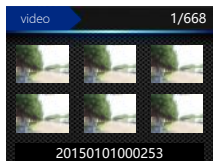

On this interface, press the “★” button to mark the current file as important. And the file will not be covered when loop recording and only can be deleted through computer.

Press the “◀◀” or “▶▶” button to select a video file to play and then press the Play button quickly to enter the Video Stop interface.

Illustration of Video Playback Interface:



- | | |
|--------------------------|------------------|
| ① Play state | ⑤ Progress bar |
| ② Current recording time | ⑥ Total time |
| ③ Time watermark | ⑦ Time file name |
| ④ ID Number watermark | |

9.1 Video Playback

Press the “◀◀” or “▶▶” button to select a file to play.

- 1 Press the “Play” button to start playing, and the status indicator will turn green.
- 2 Press “▲” or “▼” adjust volume.
- 3 Press the “Stop” button to stop playing a video and return to the video file list interface.
- 4 When playing, press to pause, press again to continue

playing.

- 5 When playing, press “⏮” or “⏭” to choose 2x, 4x, 8x, 16x, 32x, 64x, 128x to fast forward or backward.



Note

- If the headphones are plugged in, the speaker of the recorder is disabled.

10 Camera Mode

On the preview interface, you can enter the playback review interface through the Play button; press the “⏮” or “⏭” button to select Photo Playback, and then press the Play button quickly to enter the photo file list interface. The photo file list interface is shown in the following figure:

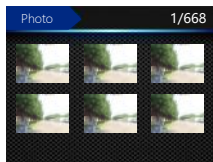

On this interface, press the sensitivity button to mark the current file as important. And the file will not be covered when loop recording and only can be deleted through computer.

Press the “⏮” or “⏭” button to select a photo file to play back, and then press the Play button quickly to enter the Photo Browse status. Press the “⏮” or “⏭” button to select the desired photos.

11 Voice Mode

On the Preview interface, you can enter the playback review interface through the Play button; press the “◀◀” or “▶▶” button to select Voice Playback, and then press the Play button quickly to enter the voice file list interface. The voice file list interface is shown in the following figure:



On this interface, press the “★” button to mark the current file as important. And the file will not be covered when loop recording and only can be deleted through computer.

Press the “◀◀” or “▶▶” button to select a voice file to play back, and then press the Play button quickly to enter the Voice Stop interface.

Illustration of Voice Playback Interface:



- ① Play state
- ② Current time
- ③ Time file name
- ④ Progress bar
- ⑤ Total time

11.1 Voice Playback

- 1 Press the “⏮” or “⏭” button to select a file for play back.
- 2 Press the “Play” button to start playing, and the status indicator turns green.
- 3 Press “▲” or “▼” to adjust volume.
- 4 Press the “Stop” button to end playing and return to the voice file list interface.
- 5 When playing, press “⏸” to pause, press “▶” again to continue playing.



Note

- If the headphones are plugged in, the speaker of the recorder is disabled.

12 Remote Control

Remote control allows the user to control the device remotely. The supplied remote control offers remote shutdown, voice record, video record, camera, and other functions.

12.1 Remote Control Enable/Disable

- 1 When the device is off, if the white lamp for the remote control indicator goes out, the remote control is disabled. At that time, press the Menu button for 3 seconds. When the white lamp is lit, later slowly flashes and the remote control is enabled.
- 2 When the device is off, if the white lamp on the remote control stays on and flicker slowly, the remote control is still turned on. Press the Power On/Off button on the remote control to remotely control the device. Press the Menu button for 3 seconds to turn off the remote control.



Note

- The remote control of the device should be enabled before using the remote control to operate the device.
- Please charge the remote control for at least 2 hours



Note

- before using for the first time!
- If the red indicator is flickering all the time when the remote control is working after the code is matched, it means it is low battery. Please charge the remote control.
 - The remote control can be enabled and disabled only when the audio and video recorder is off.
 - Only if the white lamp for the remote control indicator slowly flashes, then the remote control is enabled. The red indicator on the remote control flashes once when taking photo, twice when audio or video recording are enabled, and three times when saving recorded audio or video files.
 - The remote control allows horizontal control without a barrier at any angle within 2 meters.

12.2 Matching the Remote Control

When the device is off and the remote control is disabled, press the Menu button for 8 Sec to make the white lamp for remote control indicator flicker rapidly. The Power On/Off button on the remote control must be pressed within 3 Sec. When the white lamp stops flickering and stays on, the code match is completed. If the device will automatically start, the code match is successful. If not, code match failed.

13 HDMI

On the preview interface of recording, connect the device to a HD display devices with a Micro HDMI switch HDMI cable (cthis cable is available as an accesories), all the operations are still available.



Note

- When connecting HDMI, there are some inconsistencies between HD display devices and machine display.

14 Settings Mode

On the preview interface, press the Menu button to enter the Settings interface. See the Settings interface reference. It is comprised of Voice Settings, Video Settings, Camera Settings and System Settings.

14.1 Voice Settings

The Voice Settings menu includes Record Type and MIC Sensitivity. Press the “◀◀” or “▶▶” button to select the Voice Settings menu icon, and press the “▲” or “▼” button to select the item to be set; then press the Menu button to enter.

14.1.1 Record Type

The Record Type menu provides two options: “HQ,” and “SLP.” If HQ recording is selected, the device automatically saves the recorded file after the recording lasts for one hour, and then resumes recording. The interface reference has the following settings:

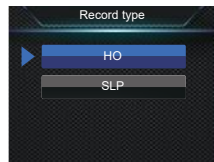

HQ: WAV format, high quality, bit rate 1536kbps.

SLP: WAV format, average quality, bit rate 385kbps.

14.1.2 MIC Sensitivity

The MIC Sensitivity menu has three options: “High, Medium, Low.” Different recording effects can be achieved by selecting different levels. The interface reference has the following settings:

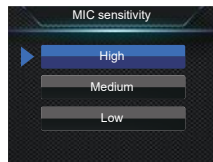

14.2 Video Settings

The Video Settings menu includes Resolution, Video Quality, Pre-record, and Delay Record. Press the “◀◀” or “▶▶” button to select the Video Settings menu icon, press the “▲” or “▼” button to select the item you wish to set, and then press the Menu button to enter.

14.2.1 Resolution

Recording resolution has five levels, i.e. 1920 × 1080 30P, 1280 × 720 60P, 1280 × 720 30P, 848 × 480 60P and 848 × 480 30P, to satisfy the needs in most scenarios. Press the “▲” or “▼” button to select the desired resolution. After selection, press the menu button to confirm, or press the Back button to return to the previous menu.

The interface reference is presented in the following figure:

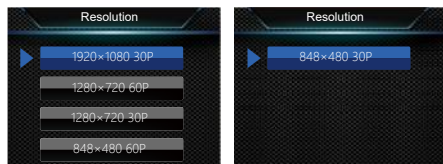

14.2.2 Video Quality

The Video Quality menu has three options: “S. Fine, Fine, Normal.” Different quality can be selected for different needs. Higher quality will require a larger file within the same recording period.

14.2.3 Pre-record

When Pre-record is enabled, you can record a video for some seconds before an event. Pre-record has two options: Off and On. Press the “▲” or “▼” button to select. After selection, press the Menu button to confirm, or press the Back button to return to the previous menu.

14.2.4 Delay Record

When Delay Record is enabled, you can keep recording for a set time after pressing the button to save the recorded video. Delay Record has six options: Off, 5 Sec, 10 Sec, 15 Sec, 30 Sec and 60 Sec. Press the “▲” or “▼” button to select. After selection, press the Menu button to confirm, or press the Back button to return to the previous menu.

14.3 Camera Settings

The Camera Settings menu includes Photo Size, Photo Quality, Photo Rate, and Auto Shooting. Press the “◀◀” or “▶▶” button to select the Camera Settings menu icon, press the “▲” or “▼” button to select the item to be set, and then press the Menu button to enter.

14.3.1 Photo Size

Photo Size has 10 levels: 20M, 16M, 14M, 12M, 8M, 5M, 3M, 2M, 1.2M and VGA. Press the “▲” or “▼” button to select the desired resolution. After selection, press the Menu button to confirm, or press the Back button to return to the previous menu. The interface reference is illustrated below:

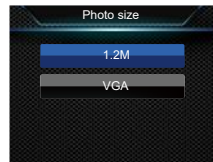
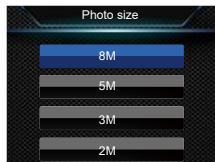
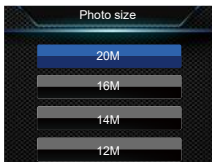

14.3.2 Photo Quality

On the Camera Settings menu, select the “Photo Quality” menu, and then press the Menu button to enter the Photo Quality menu. The Photo Quality menu has three options: “S, Fine, Normal.” Different quality is selected for different needs. The better quality, the larger file within the same recording period.

14.3.3 Photo Rate

Photo Rate means that the device can take photos continuously by pressing the Camera button once in the preview mode or in the course of video recording. On the Camera Settings menu, select the "Photo Rate" menu, and then press the Menu button to enter the Photo Rate menu. The Photo Rate menu has five options: Off, 3 P, 5 P, 10 P and 20 P. Press the "▲" or "▼" button to select the desired photo rate. After selection, press the Menu button to confirm, or press the Back button to return to the previous menu.

14.3.4 Photo selftimer

Photo selftimer means that the device takes a photo at regular intervals when the Camera button is pressed in the Preview mode or in the course of video recording, until the Camera button is pressed, the card is full or the battery is empty.

Photo selftimer offers six options: Off, 3 Seconds, 5 Seconds, 10 Seconds, 30 Seconds and 60 Seconds. Press the "▲" or "▼" button to select the desired number of seconds. After selection, press the OK button to confirm, or press the Back button to return to the previous menu.

14.4 System Settings

The System Settings menu comprises Language, TV Mode, Default Settings, LCD Brightness, System Time, Auto Off, LCD Auto Off, Volume, In-car Model, Video Loop, In-car Record, Duration Off, Key Tone, Light Indicator, Infrared Switch, Motion Detection, EV, ID Number and System Information. Press the "◀◀" or "▶▶" button to select the System Settings menu icon, and press the "▲" or "▼" button to select the item to be set, and then press the Menu button to enter.

14.4.1 Language

On the Language menu, you can select the desired language as the system language. The Language interface reference is illustrated below:



14.4.2 TV Mode

TV Mode has two options: NTSC and PAL. When the device is linked to TV, the correct option is selected based on the TV mode.

14.4.3 Default Settings

This allows the user to reset the parameters of the device.

14.4.4 LCD Brightness

This allows the user to adjust the LCD to the required brightness. The LCD brightness has three levels: High, Medium and Low. Press the “▲” or “▼” button to select the desired level. After selecting the level, press the OK button to confirm, or press the Back button to return to the previous menu.

14.4.5 System Time

The System Time interface is illustrated below:



On the interface, press “▲” or “▼” and “◀◀” and “▶▶” to set the current time. Press “◀◀” and “▶▶” to select Year, Month, Day; and press “▲” or “▼” to change these value.

14.4.6 Auto Off

If the user does not perform an operation on the device over a pre-set time, the system automatically shuts down. See the auto off setting interface reference below:

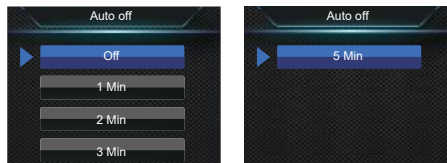

14.4.7 LCD Auto Off

LCD Auto Off has 5 options: OFF, 1 Min, 2 Min, 3 Min and 5 Min. If no operations performed on the device by the user during a set time period, the LCD automatically turns itself off. If "OFF" is selected, the LCD will be remain on.

14.4.8 Volume

This function allows you to adjust the sound volume of the device.

Volume can be set to any of 17 values within 0 to 16. Press the "▲" or "▼" button to select the desired value and confirm by pressing the Menu button.

14.4.9 In-car mode

The device can be used as car driving recorder which defaults to "Off", and "Video loop" and "Video loop" are unavailable at this time. When the "In-car mode" is on, "Video loop" and "Video loop" are unavailable and "LCD auto Off" defaults to "Off".

14.4.10 Video loop

On the video recording setting menu, choose "Video loop" and press menu button to confirm. Press "▼" or "▲" to choose "On/Off" and press menu button to confirm, return button to return to the previous menu.

The interface is as below:

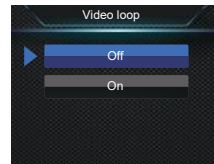

14.4.11 In-car recording

Choose whether to record the voice in car or not by this function.

14.4.12 Duration

Video recording has five time periods: 5 Min, 10 Min, 15 Min, 20 Min and 30 Min. In the course of video recording, this function can automatically save a video file periodically at the selected time interval, and enter the recording for the next time period without any delay. The automatic off interface reference is illustrated below:

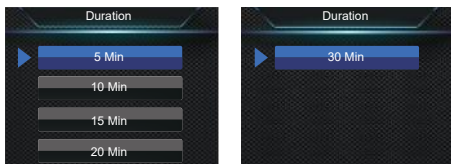

14.4.13 Key Tone

This function creates a sound when any button is pressed if the recording is stopped. Turn on/off key tone with this function.

14.4.14 Indicator light

Turn on/off indicator according to needs.

14.4.15 Infrared Switch

On the System Settings menu, press the ▲ or ▼ button to select the "Infrared" menu, and then press the Menu button to enter the Infrared Switch menu. The menu offers two options: Manual and Auto. After selecting the mode, press the OK button to confirm, or press the Back button to return to the previous menu.

14.4.16 Motion Detection

In detection mode, the Voice Tracer automatically starts recording when any object enters the coverage of the body worn camera. After the object gets out of the range of coverage, it ends the recording and saves the recorded file. Motion detection has four options: Off, Low, Medium and High. It can be turned off or set to a desired level.

14.4.17 EV

As an exposure control mode, EV can adjust the brightness of photos. You can adjust the brightness for unique visual effects.

EV can be set to any of 13 values within -2.0 to +2.0. Press the “▲” or “▼” button to select the desired exposure value. Press the Menu button to confirm after selection.

14.4.19 ID Number

The PID setting interface is illustrated below:

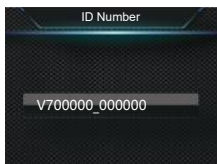

On the interface, press “▲” or “▼” and “◀◀” and “▶▶” to set the Equipment No. and User No. of the device. Press “ ” and “ ” to select the corresponding value, and press “ ” or “ ” to move to the corresponding figure.

14.4.20 System Information

The System Information menu includes Total Space, Available Space, Remain Video, Remain Sound, Battery Power and Firmware Version;

Total Space: This allows the user to check the amount of memory space in the device.

Available Space: This allows the user to check the remaining space available.

Remain Video: This allows the user to check how long the device can record for the current video resolution.

Remain Sound: This allows the user to check how long the device can record for the current record type.

Battery Power: This allows the user to check the current battery power.

Firmware Version: This allows the user to check the version of firmware.

15 Changing the battery

15.1 Battery loading

- 1 Push the battery cover latch to "OPEN" direction to open the lid.
- 2 Put battery into the slot as shown in below picture:

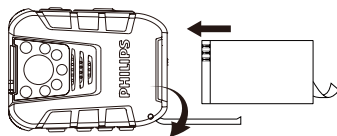

- 3 Recover the battery cover to the original position.

15.2 Battery unloading

- 1 Push the battery cover latch to "OPEN" direction to open the lid.
- 2 Take out the battery.
- 3 Recover the battery cover to the original position.

16 How to use the back clip

16.1 Back clip installment

Match the back clip with the slot ① on the device, and install the clip according to direction ②, as shown in below picture.

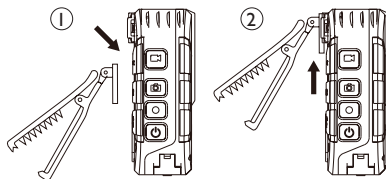

16.2 Back clip uninstallment

Pull out the clip from in opposite and up direction.

17 How to wear the back clip

- (1) Open the clip by pressing the finger position, then nip the epeulet and make the clip hook hookup the bottom of the epaulet.

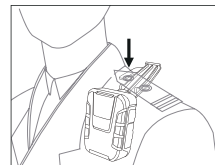

- (2) Adjust the device to a proper position.



18 FAQs

Answers to the frequently asked questions are listed here to solve simple problems with the recorder. If the problem cannot be solved, please contact the dealer or visit our official website:
www.philips.com/support

My Voice Tracer cannot power on:

The battery is out of power, please recharge promptly.

Incorrect time/date:

Please set the time/date in the menu if the recording time is incorrect.

Blurred photo/video:

If the camera lens are unclean, please clean up the lens with a piece of flannelette.

My Voice Tracer does not record anything:

The Voice Tracer's memory is full, and the loop record is off. Please delete some recordings or move them to other storage devices.

My Voice Tracer does not play recordings:

The battery is out of power, please recharge.

My Voice Tracer crashes:

If the device cannot start, display a black screen or fails to function, resetting the device provides the most common solution. A reset button is located under the rubber plug of USB& HDMI. The recorder can be reset by using tweezers or any pointed object to press inside the pinhole.



Note

- This operation will not cause any loss or damage to files.

19 Technical Parameters

Storage

Internal Storage

Estimated Recording Time (16GB): around 22 hours with HQ recording mode, around 90 hours with SLP Recording mode

Type of Internal Storage: C10 TF card

Portable Storage (PC): Yes

Dimensions and Weight

Wide × Long × High: 77 × 54 × 27 (mm)

Weight (with battery): 106g

System Requirements

Operating System: Windows 10/8/7/Vista/XP/2000,

Mac OS X, Linux

Port: USB

Voice Record

HQ REC: bit rate 1536kbps, WAV format

SLP REC: bit rate 385kbps, WAV format

Operating Conditions

Temperature: -30–55°C

Humidity: 10–90%, no condensation

Warranty card

质保书

1

year warranty

一年质保

Type: VTR8100

Serial nr:

Date of purchase

购买日期

Dealer's name, address and signature

销售商名称、地址及签字

www.philips.com/welcome

This document is printed on chlorine free produced paper
Data subject to change without notice

This product was brought to the market by Speech Processing Solutions GmbH or one of its affiliates, further referred to in this document as SPS, which is the manufacturer of the product. SPS is the warrantor in relation to the product with which this booklet was packaged.

For China only
仅限中国地区

Printed in China



